



4G+ Cat6 AX1500 Wireless Dual Band Gigabit Router

Enjoy 4G+ Speed
Sharing Everywhere



Archer MX700



Full Gigabit
Ethernet Ports[◇]



MU-MIMO
Technology[†]



EasyMesh-Compatible
Create Seamless Wi-Fi[§]



Advanced Security
with WPA3[△]

Highlights

Fast 4G+ Mobile Broadband Speed

Supports the 4G+ Cat6, which uses Carrier Aggregation technology to boost LTE speeds, MX700 provides fast broadband speeds up to 300 Mbps as your reliable internet access. Plug your SIM card and enjoy HD movies without interruption, downloading files in seconds, and smooth online gaming.

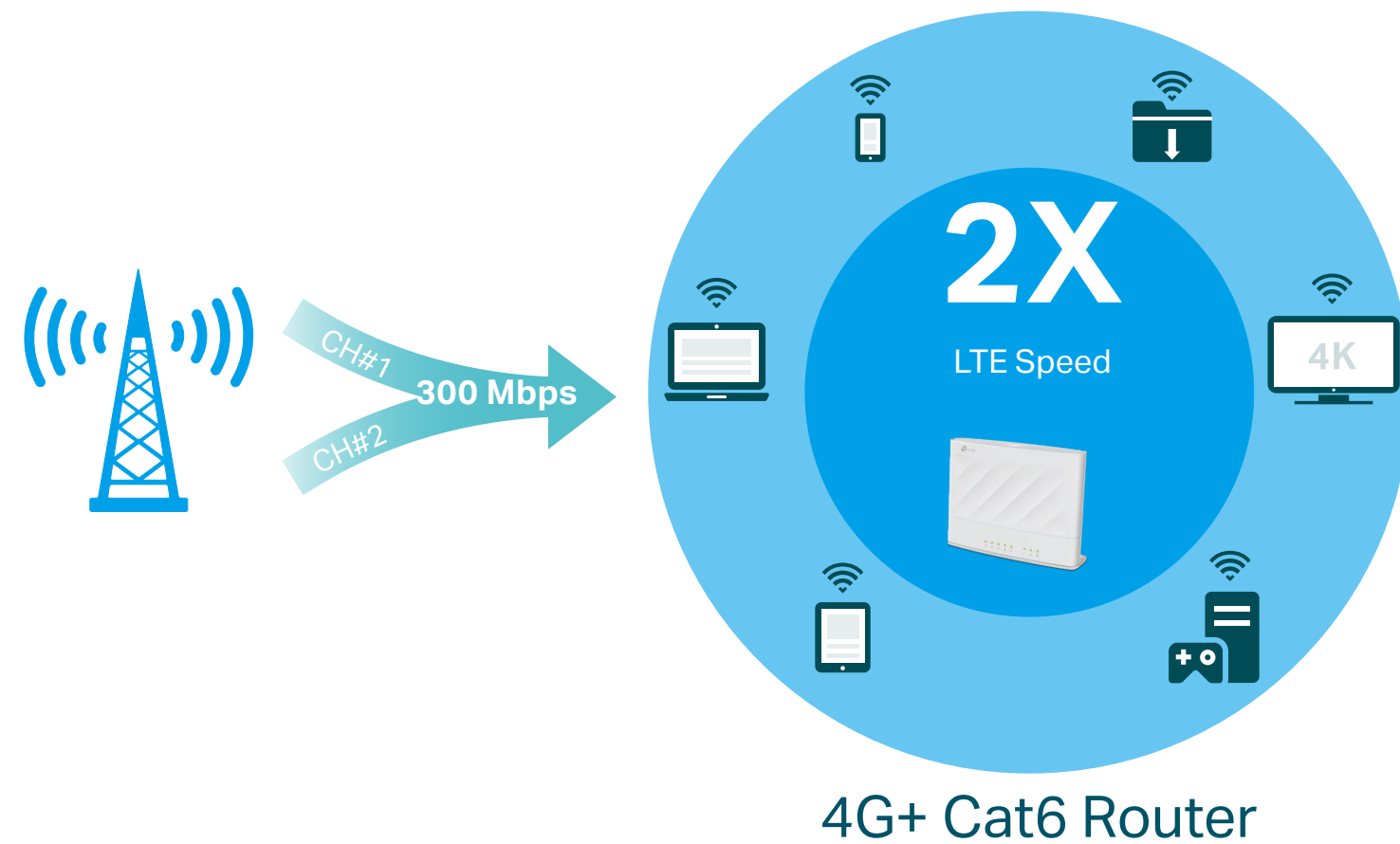

Vast Wi-Fi Coverage Throughout Your Home

Beamforming concentrates signal towards your connected devices, Power Amplifier and Low Noise Amplifier boost sending and receiving capabilities, both of which boost the signal coverage. Hence MX700 creates a wide and strong AX1500 dual band Wi-Fi network throughout your home.

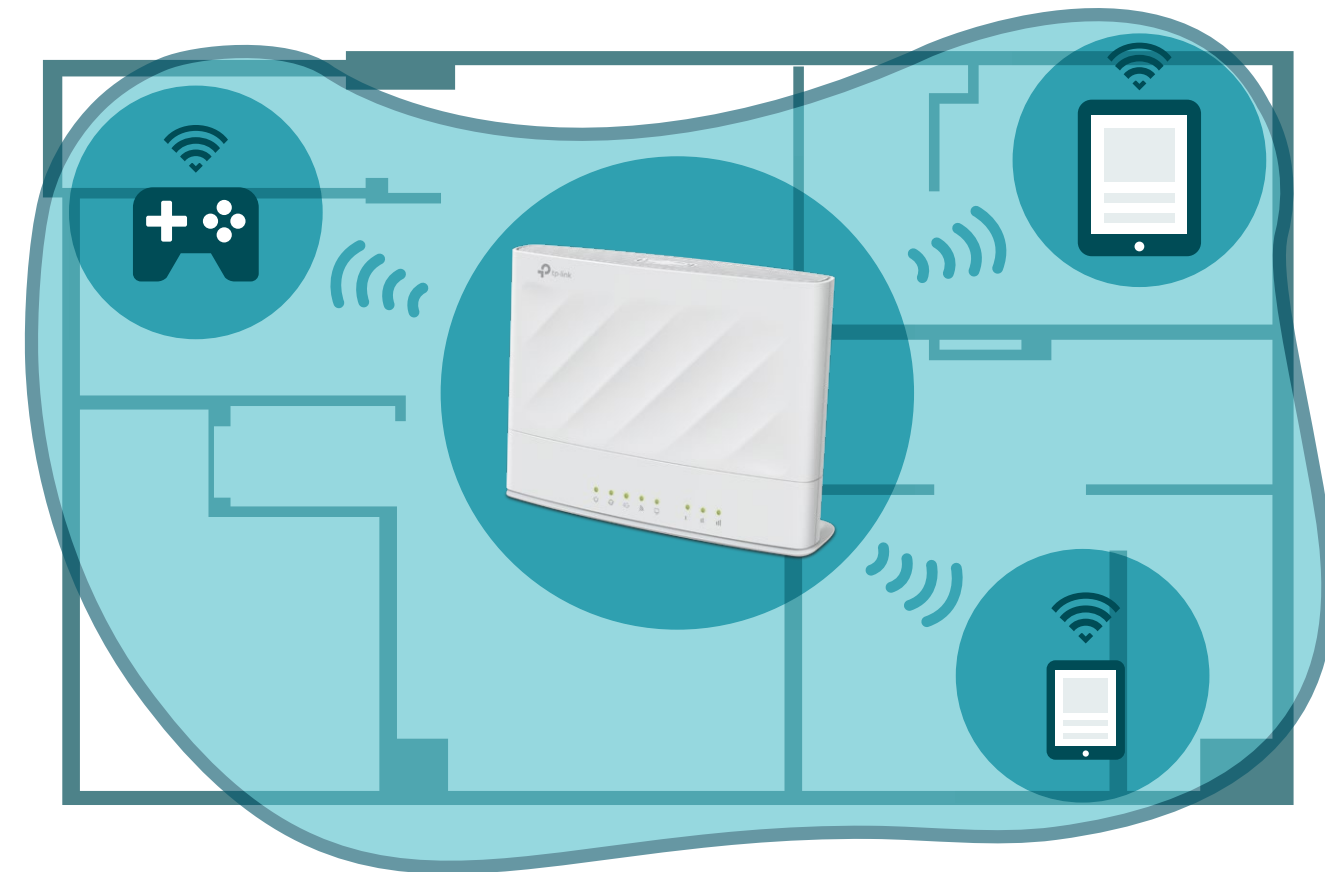

Highlights

MU-MIMO for Higher Efficiency

MU-MIMO technology serves multiple devices at once, reducing wait time, increasing Wi-Fi throughput for every device, and making each stream more efficient.†



Traditional Router



MU-MIMO Router

More Devices, More Stability

Connect up to 128 wireless devices with ease, thanks to a powerful processor that boosts data transfer speeds while ensuring dependable network stability.†

Up to
128
devices

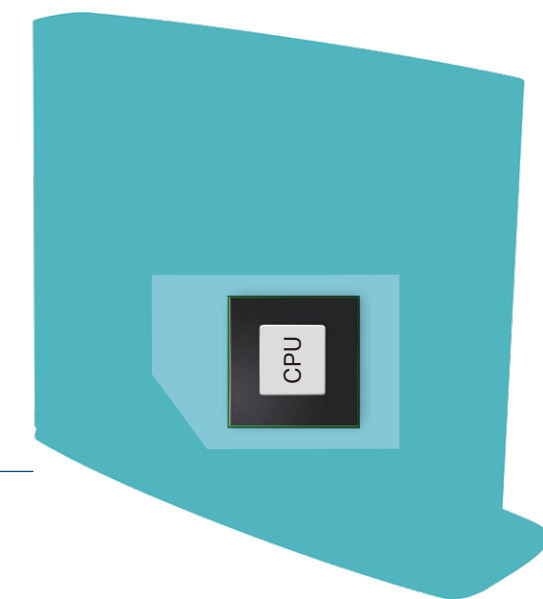

Powerful CPU

Highlights

Available WAN Connection

The gigabit WAN/LAN port enables MX700 to work as a traditional wireless router which is compatible with cable, fiber, and DSL modems. And when it's set as a wireless router, its 3G/4G connection works as a backup to provide a sustained and reliable internet connection for you.

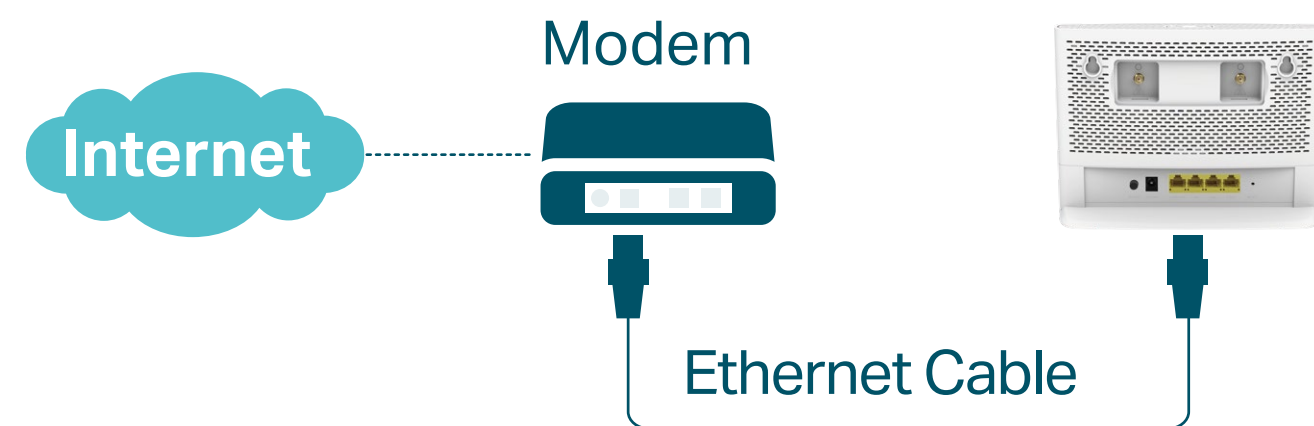

EasyMesh-Compatible

Mesh networking creates smooth, fast, stable roaming. MX700 can build an EasyMesh network with devices that use EasyMesh technology. Eliminate Wi-Fi dead zones, expand your network and fill your entire home with high-speed Wi-Fi.[§]

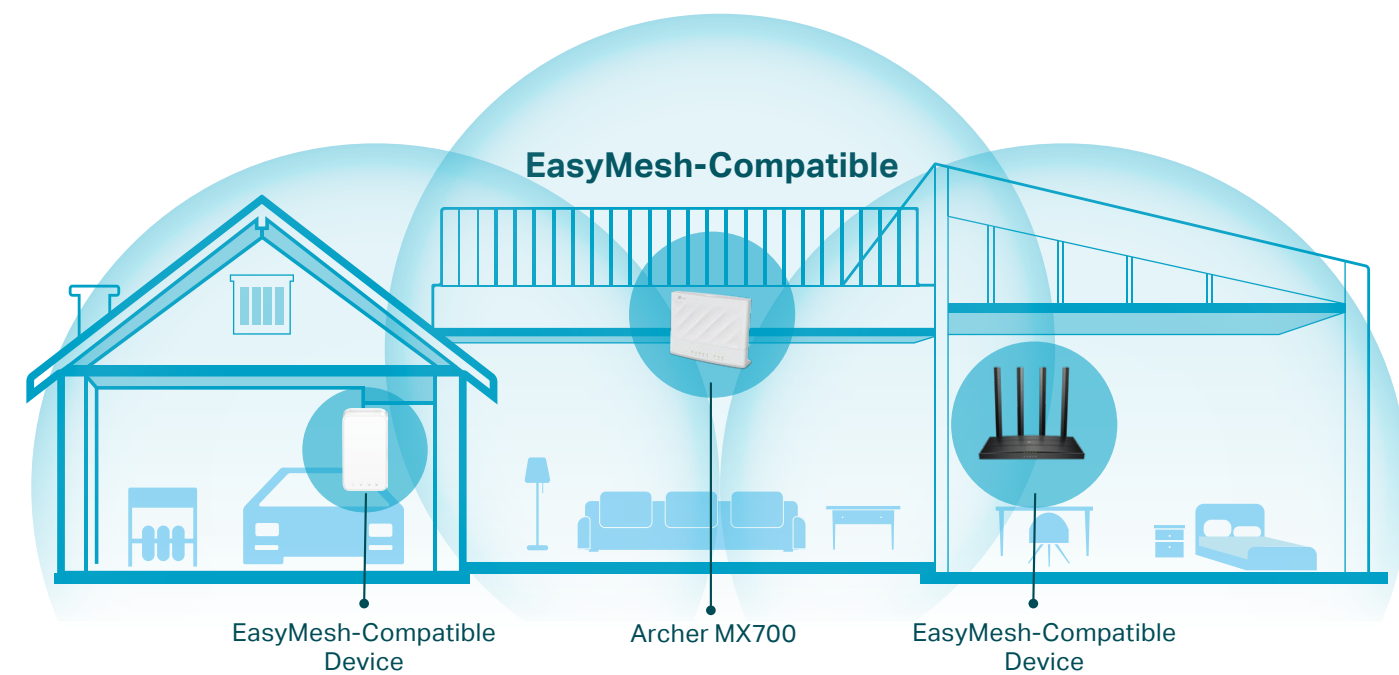

Check full list of EasyMesh-Compatible routers and range extenders at:
<https://www.tp-link.com/easymesh/product-list/>
*More compatible devices are coming soon.

Features

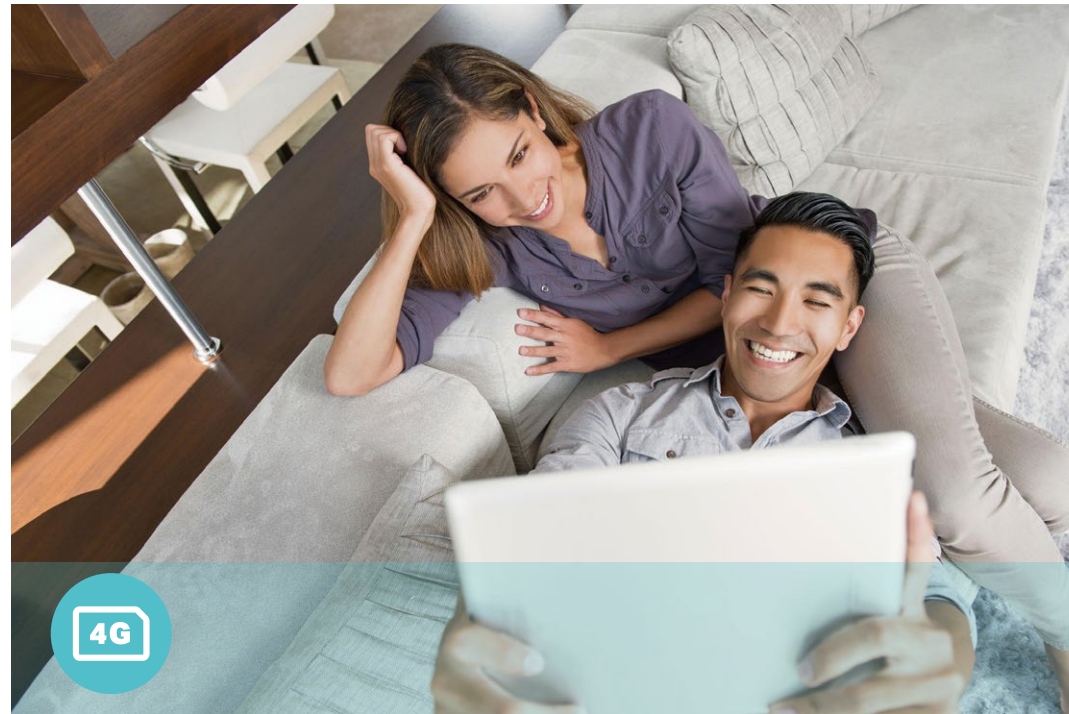

4G+ LTE

- 4G+ LTE – Ideal for cutting-edge 4G LTE Advanced network
- Backward Compatible – Compatible with 3G/4G network



Wi-Fi Speed

- Superior Wireless Speed – Combined wireless speeds up to 1201 Mbps over 5 GHz, and 300 Mbps over 2.4 GHz
- 802.11 ax Standard – Provides a data transfer rate 3 times faster than 802.11n for each stream



Reliability

- Simultaneous Dual Band – Separate Wi-Fi bands enable more devices to connect to your network without a drop in performance
- Easy Bandwidth Management – Advanced QoS makes it easier for you to manage the bandwidth of connected devices
- Superior Stability – Powerful processor enables you to connect up to 128 wireless devices with ease

Features



Ease of Use

- Intuitive Web UI – Ensures quick and simple installation without hassle
- Fast Encryption – One-touch WPA wireless security encryption with the WPS button
- Hassle-free Management with Tether App – Network management is made easy with the TP-Link Tether App, available on any Android and iOS device
- Online Upgrade – Keeps you informed of the latest firmware and allows online upgrade on the web UI



Security

- Guest Network – Keeps your main network secure by creating a separate network for friends and visitors
- Access Control – Establishes a whitelist or blacklist to allow or restrict certain devices to access the internet
- Parental Controls – Restrict internet access time and contents for children devices
- Encryptions for Secure Network – WPA-PSK, WPA2-PSK and WPA3-PSK encryptions provide active protection against security threats

Specifications

Wireless

- Network Type
Compatible with majority of mobile operators and supports 4G/3G:
4G: FDD-LTE: B1/B3/B5/B7/B8/B20/B28 (2100/1800/850/2600/900/800/700 MHz)
TDD-LTE: B38/B40/B41(2600/2300/2500 MHz)
3G: DC-HSPA+/HSPA/UMTS: B1/B5/B8(2100/850/900 MHz)
- Wireless Standards: IEEE 802.11a/n/ac/ax 5 GHz, IEEE 802.11b/g/n 2.4 GHz
- Frequency: 2.4 GHz and 5 GHz
- Signal Rate: 300 Mbps at 2.4 GHz, 1201 Mbps at 5 GHz
- EIRP (CE): < 20 dBm (2.4 GHz), < 23 dBm (5 GHz)
- Reception Sensitivity:
 - 5 GHz: 11a 54M: -77 dBm
 - 11ax HE20:-64 dBm
 - 11ax HE40: -61 dBm
 - 11ax HE80:-59 dBm
 - 11ac VHT20: -69 dBm
 - 11ac VHT40: -66 dBm
 - 11ac VHT80 : -63 dBm
 - 11n HT20: -74 dBm
 - 11n HT40: -71 dBm
 - 2.4 GHz: 11g 54M: -78 dBm
 - 11n HT20: -75 dBm
 - 11n HT40: -72 dBm
- Wireless Function: Enable/Disable Wireless Radio, Wireless Schedule, WMM
- Wireless Security: 64/128-bit WEP, WPA/WPA2 Personal, WPA/WPA2 Enterprise, WPA/WPA3 Personal

Hardware

- 4G+ Cat6: Download Speed 300 Mbps + Upload Speed 50 Mbps
- Wireless: 300 Mbps on 2.4 GHz + 1201 Mbps on 5 GHz
- Antennas: 2× Internal 4G/3G Antennas + 2× Internal Wi-Fi Antennas + 2× External Antenna Ports
- Ports: 1× Gigabit LAN/WAN Port + 3× Gigabit LAN Ports
- Dimensions: 7.86×5.85×2.66 in (199.7×148.6×67.5 mm)

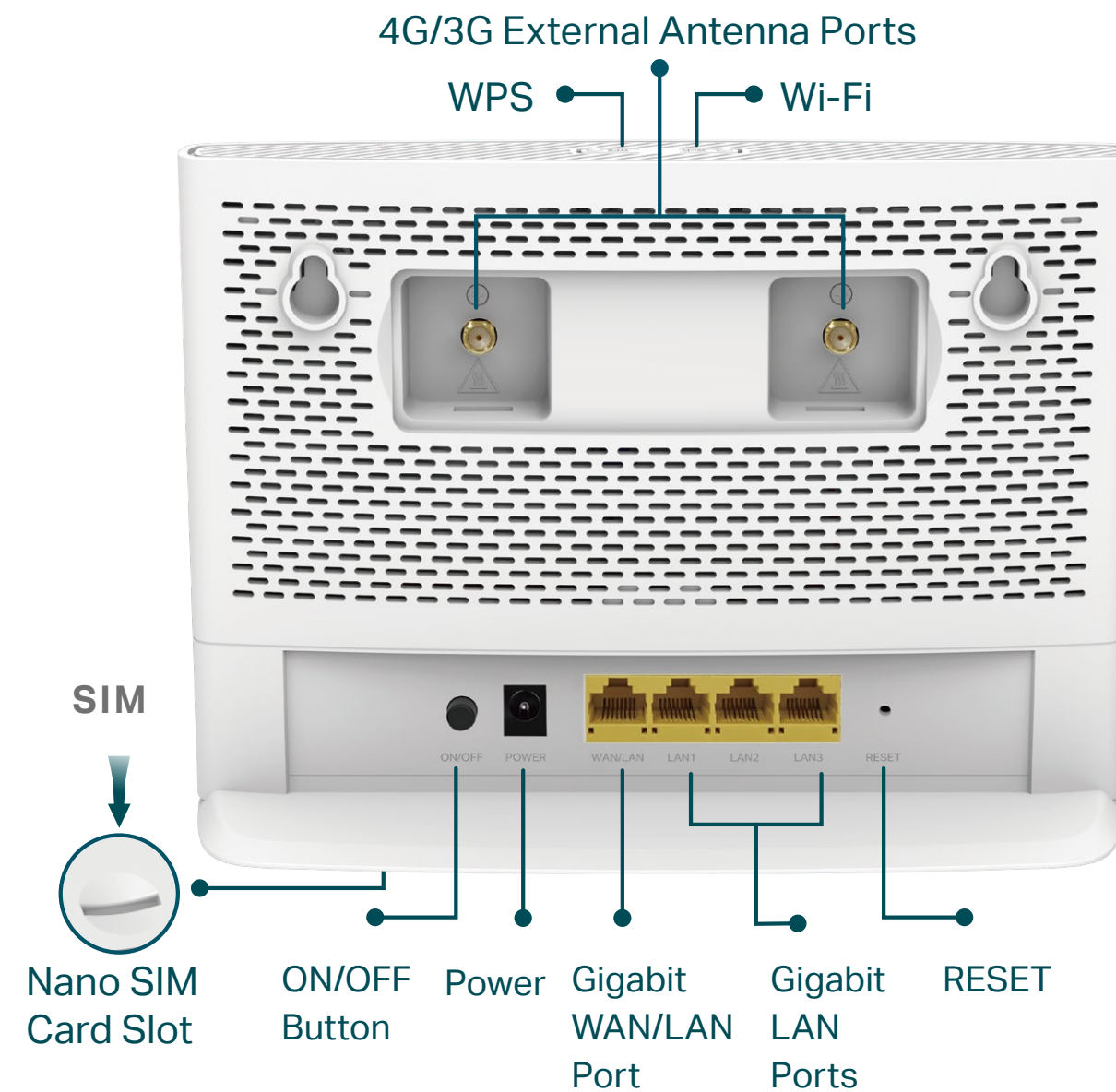

Specifications

Software

- Operating Modes: 3G/4G Router, Wireless Router
- WAN Type: Dynamic IP/Static IP/PPPoE/PPTP(Dual Access)/L2TP(Dual Access)
- DHCP: Server, DHCP Client List, Address Reservation
- Quality of Service: Bandwidth Control
- Port Forwarding: Virtual Server, Port Triggering, UPnP, DMZ
- Dynamic DNS: TP-Link, DynDns, NO-IP
- Security: IPv4 SPI Firewall, ALG, IP and MAC Address Binding, Access Control
- Protocols: IPv4, IPv6
- Management: TP-Link Cloud, Local Management, Remote Management
- Administration: Upgrade Firmware, Factory Default, System Log, Diagnostic Tools
- Guest Network: 2.4 GHz Guest Network x 1, 5 GHz Guest Network x 1

Others

- Certification:
CE, RoHS
- Requirements:
Edge, Firefox, Chrome, Safari, or other JavaScript-enabled browser
*You are recommended to use the latest version
Nano SIM Card
- Environment:
Operating Temperature: 0°C~40°C (32°F ~104°F)
Operating Humidity: 10%~90% non-condensing
Storage Humidity: 5%~90% non-condensing
- Package Contents
4G+ Cat6 300 Mbps LTE AX1500 Wireless Dual Band Gigabit Router Archer MX700
Power Adapter
RJ45 Ethernet Cable
Quick Installation Guide



For more information, please visit

https://www.tp-link.com/products/details/?model=Archer+MX700_V1

or scan the QR code left

Attention: This device may only be used indoors in all EU member states, EFTA countries and Northern Ireland.

Attention: This device may only be used indoors in Great Britain.

Specifications are subject to change without notice.

†Maximum wireless signal rates are the physical rates derived from IEEE Standard 802.11 specifications. Actual wireless data throughput and wireless coverage, and number of connected devices are not guaranteed and will vary as a result of network conditions, client limitations, and environmental factors, including building materials, obstacles, volume and density of traffic, and client location.

‡Use of MU-MIMO requires clients to also support MU-MIMO.

§TP-Link EasyMesh-compatible products can network with other devices that use EasyMesh. Failed connections may be due to firmware conflicts of different vendors. The EasyMesh-Compatible function is still being developed on some models and will be supported in subsequent software updates. This product is compatible with standardized EasyMesh technology but has not obtained the Wi-Fi EasyMesh™ certification.

◇Actual network speed may be limited by the rate of the product's Ethernet WAN or LAN port, the rate supported by the network cable, Internet service provider factors and other environmental conditions.

♣Use of WPA3 requires clients to also support the corresponding feature.

*This device requires an activated SIM card without a PIN lock. If the SIM is locked, please consult the quick installation guide for unlocking instructions.

©2025 TP-Link

www.tp-link.com